



T8DD MEDIUM VILLAGGIO CON ALTALENA

T8DD MEDIUM VILLAGE WITH SWING

VISTA TRIDIMENSIONALE

THREE-DIMENSIONAL VIEW

SCHEDA TECNICA (TECHNICAL DATA SHEET)		
ART. T8DD	16-06-2022	SCALA (SCALE)
LE MISURE SONO ESPRESSE IN MM. (MEASUREMENTS ARE EXPRESSED IN MM.)		
	TIEGI SRL VIA BENEDETTO CROCE 7, Z.I. "CONDOTTI BARDINI", 31058 SUSEGANA (TV) 0438-460645	
	<small>Ci riserviamo a termini di Legge la proprietà di questo disegno con divieto di renderlo comunque noto a terzi senza la nostra approvazione. We reserve the right to read the ownership of this design with the prohibition of making it known to third parties without our approval</small>	FOGLIO 1 DI 5

PIANTA
(PLAN)

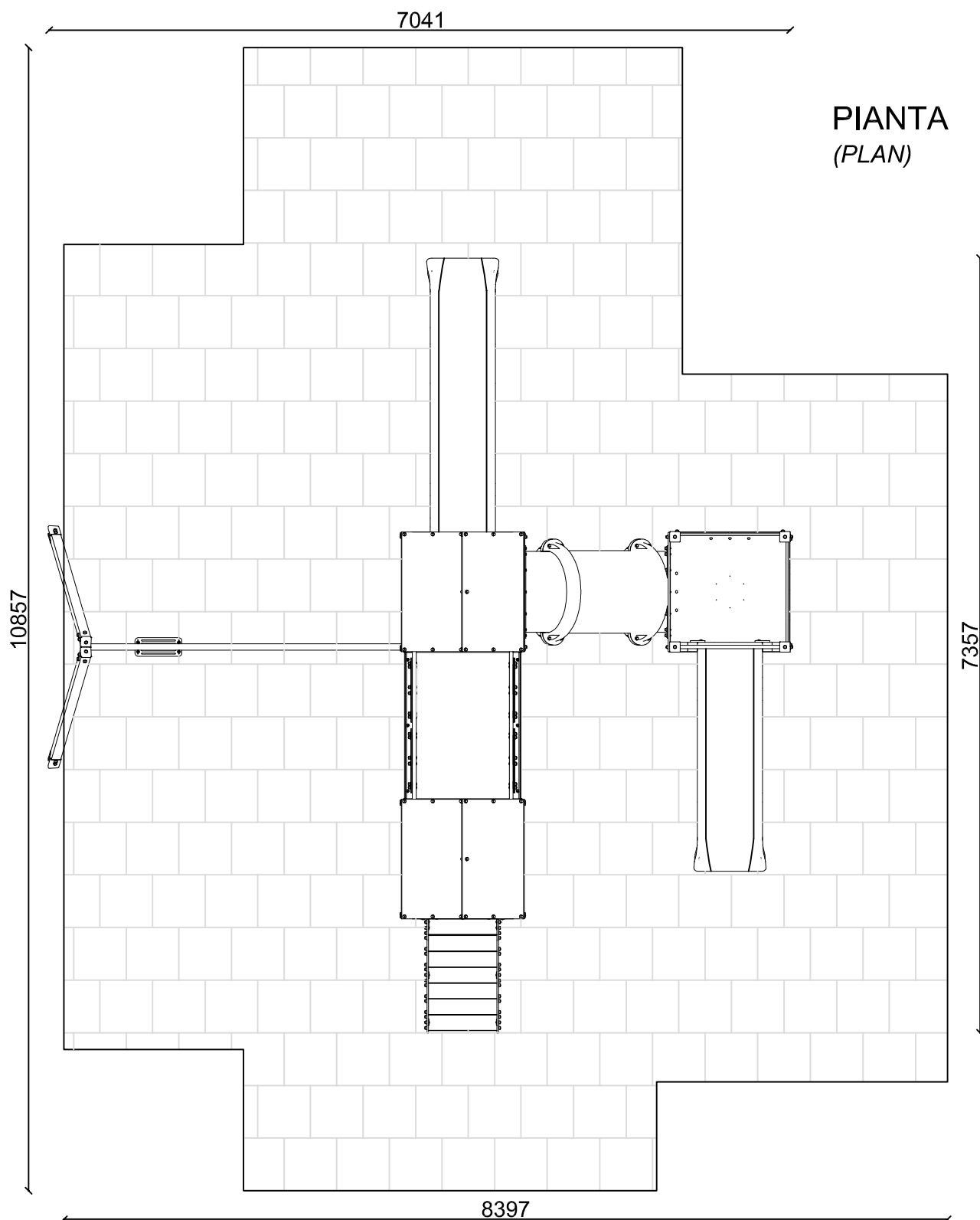

AREA DI SICUREZZA (IMPACT AREA) 75 MQ

SCHEMA TECNICA (TECHNICAL DATA SHEET)		
ART. T8DD	16-06-2022	SCALA (SCALE) 1:55
LE MISURE SONO ESPRESSE IN MM. (MEASUREMENTS ARE EXPRESSED IN MM.)		
	TIEGI SRL VIA BENEDETTO CROCE 7, Z.I. "CONDOTTI BARDINI", 31058 SUSEGANA (TV) 0438-460645	
	Ci riserviamo a termini di Legge la proprietà di questo disegno con divieto di renderlo comunque noto a terzi senza la nostra approvazione. We reserve the right to read the ownership of this design with the prohibition of making it known to third parties without our approval	
		FOGLIO 2 DI 5



ALTEZZA DI CADUTA MAX. (SEAT HEIGHT)
150 cm



ETA' (AGE GROUP)
2 - 12 ANNI



NUMERO UTILIZZATORI
(MAX N. OF SIMULTANEOUS USERS) 3+



INGOMBRO (OVERALL DIMENSION)
704 cm X 736 cm X 360 cm H.



AREA DI SICUREZZA (IMPACT AREA)
840 cm X 1086 cm



SUP. ANTITRAUMA (MINIMUM SPACE)
75 MQ.

Si raccomanda di utilizzare una superficie antitrauma adatta all'altezza di caduta massima (rif. EN1177)

SCHEMA TECNICA (TECHNICAL DATA SHEET)

ART. T8DD

16-06-2022

SCALA (SCALE)

LE MISURE SONO ESPRESSE IN MM. (MEASUREMENTS ARE EXPRESSED IN MM.)

TOFFOLI
Giochi
Playgrounds for a playful world

TIEGI SRL
VIA BENEDETTO CROCE 7, Z.I. "CONDOTTI BARDINI", 31058 SUSEGANA (TV)
0438-460645
Ci riserviamo a termini di Legge la proprietà di questo disegno con divieto di renderlo comunque noto a terzi senza la nostra approvazione.
We reserve the right to read the ownership of this design with the prohibition of making it known to third parties without our approval

FOGLIO 3 DI 5

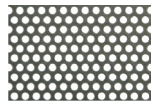

TETTO IN LAMIERA FORATA LACCATA A POLVERE

RINGHIERA COMPOSTA DA PANNELLI IN HDPE 2 COLORI AVVITATI A TAVOLE IN LEGNO

TUNNEL IN POLIETILENE DM. INTERNO 770MM

TRAVERSA ALTALENA, TUBO LACCATO A POLVERE

SCIVOLO H.150CM IN POLIETILENE ROTAZIONALE

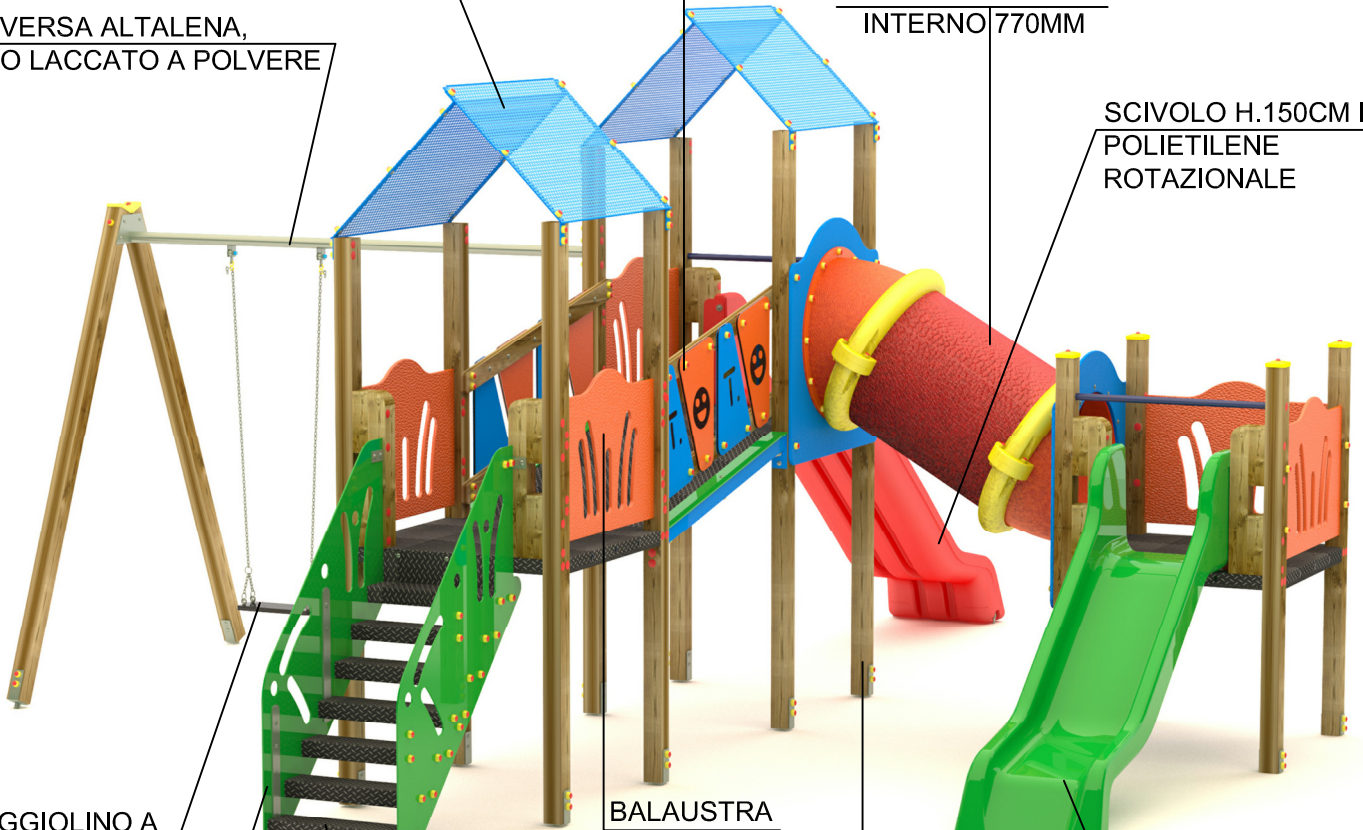

SEGGIOLINO A TAVOLETTA IN GOMMA CON ANIMA IN ACCIAIO

BALAUSTRATA SUPERIORE TORRE IN HDPE

SCIVOLO IN POLIETILENE ROTAZIONALE

BALAUSTRATA PER SCALA H.120 CM IN HDPE

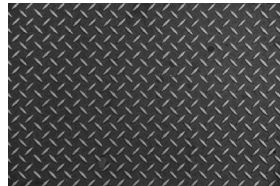

GRADINI E PIANALI IN LAMIERA BUGNATA LACCATI A POLVERE

PALO LAMELLARE DI PINO NORDICO IMPREGNATO IN AUTOCLAVE CON ANGOLI ARROTONDATI DA 90X90MM., DOTATO DI STAFFA PER FISSAGGIO SU TERRENO O CLS

TUTTI GLI ELEMENTI DI FISSAGGIO, VITI, DADI, RONDELLE ECC. SONO IN ACCIAIO ZINCATO E PROTETTI DA GHIERE E TAPPI IN POLIETILENE

SCHEMA TECNICA (TECHNICAL DATA SHEET)

ART. T8DD

16-06-2022

SCALA (SCALE)

LE MISURE SONO ESPRESSE IN MM. (MEASUREMENTS ARE EXPRESSED IN MM.)



TIEGI SRL
VIA BENEDETTO CROCE 7, Z.I. "CONDOTTI BARDINI", 31058 SUSEGANA (TV)
0438-460645

Ci riserviamo a termini di Legge la proprietà di questo disegno con divieto di renderlo comunque noto a terzi senza la nostra approvazione.
We reserve the right to read the ownership of this design with the prohibition of making it known to third parties without our approval

FOGLIO 4 DI 5

VISTA LATERALE
(LATERAL VIEW)

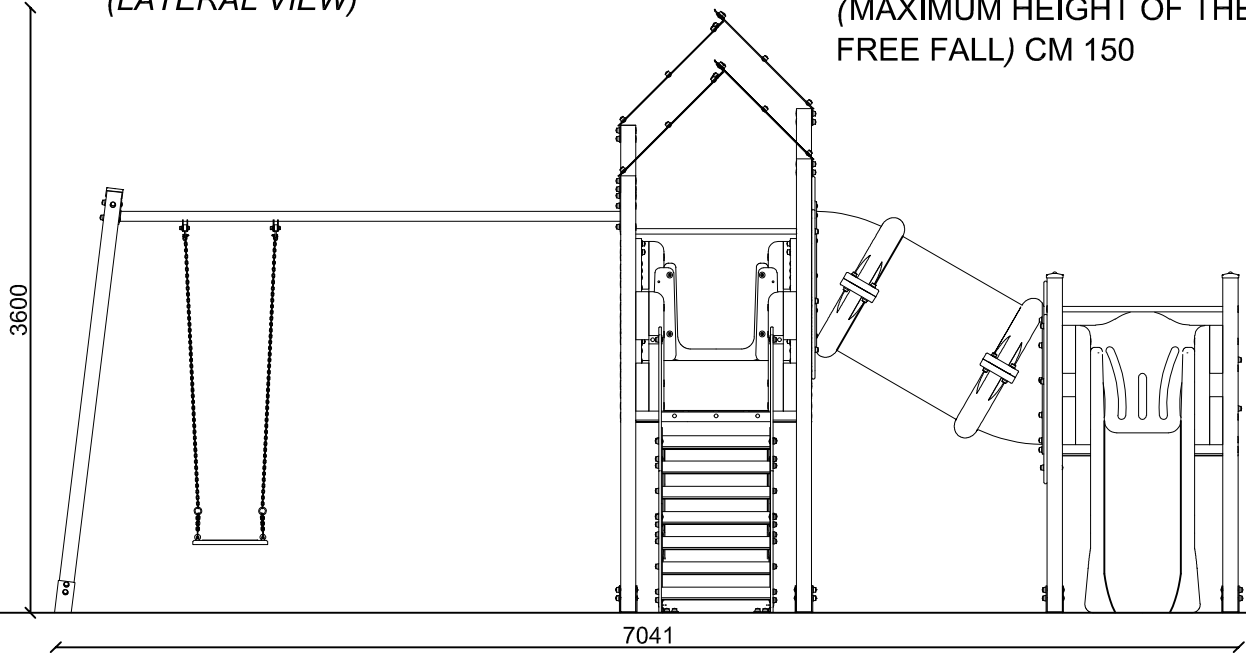

ALTEZZA MASSIMA DI
CADUTA LIBERA
(MAXIMUM HEIGHT OF THE
FREE FALL) CM 150

VISTA FRONTALE
(FRONTAL VIEW)

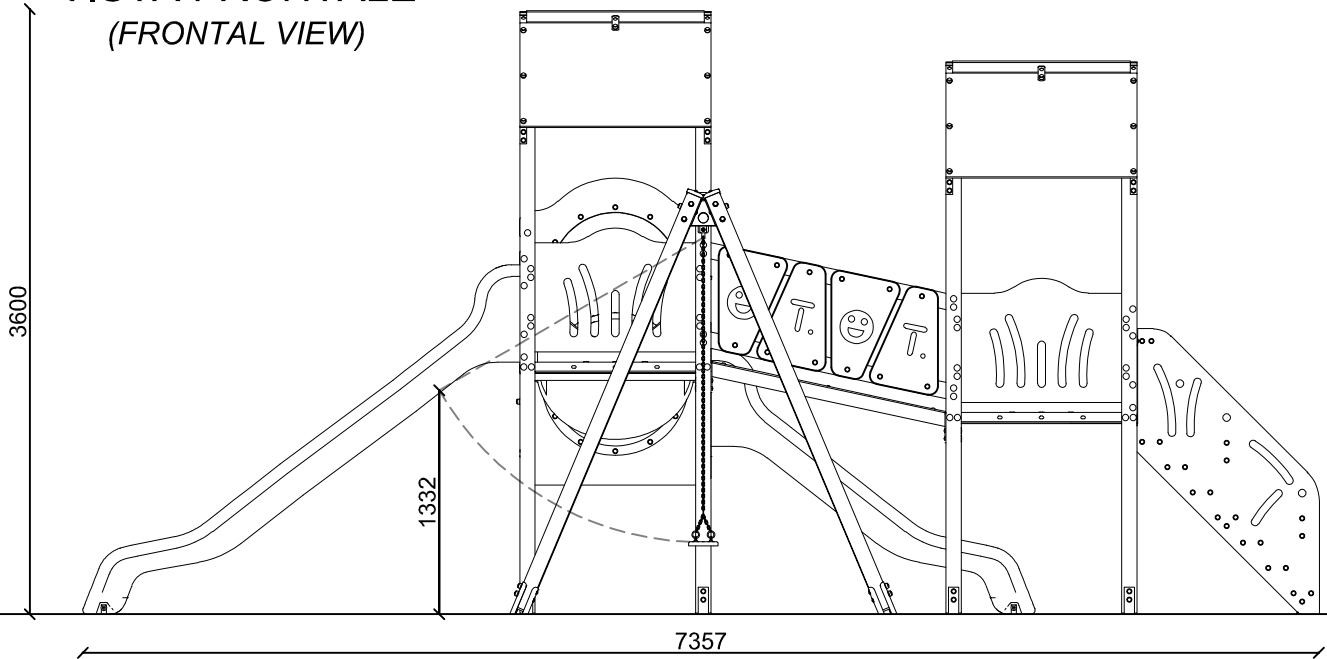

INGOMBRO MAX (OVERALL DIMENSIONS)

SCHEDA TECNICA (TECHNICAL DATA SHEET)		
ART. T8DD	16-06-2022	SCALA (SCALE) 1:45
LE MISURE SONO ESPRESSE IN MM. (MEASUREMENTS ARE EXPRESSED IN MM.)		
	TIEGI SRL VIA BENEDETTO CROCE 7, Z.I. "CONDOTTI BARDINI", 31058 SUSEGANA (TV) 0438-460645	
	Ci riserviamo a termini di Legge la proprietà di questo disegno con divieto di renderlo comunque noto a terzi senza la nostra approvazione. We reserve the right to read the ownership of this design with the prohibition of making it known to third parties without our approval	FOGLIO 5 DI 5